

# Flat Direct Irradiate Ring Illumination [IDR-F Series]

Wide range uniform illumination with LEDs mounted on a flat surface

24V DC Models Available

- Applications**
- Beverage bottles/Plastic molding industry etc.
    - ➔ Inspection for top surface chipping etc.
  - Semiconductor/Electronic components industry etc.
    - ➔ Inspection of characters on chip components and other parts etc.
  - Automotive parts/ on-board/ machinery parts industry etc.
    - ➔ Recognition of characters and bar codes on plastic/resin parts etc.

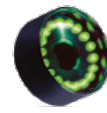
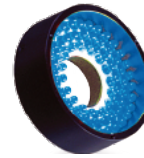
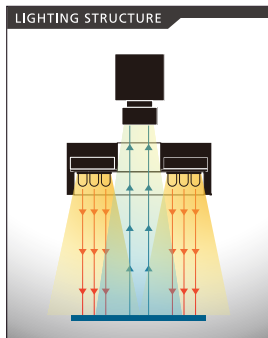

Standard Size Lineup

Standard release in 7 sizes:  $\phi 43 / \phi 50 / \phi 60 / \phi 70 / \phi 90 / \phi 100 / \phi 110\text{mm}$

## Imaging Example

Imaging of a wide area is possible with flat illumination from the top



IDR-90/50DW



IDR-F90/50DW

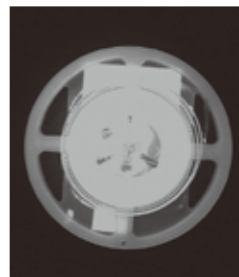

IDR-90/50DR

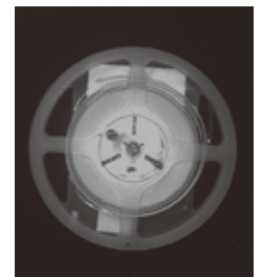

IDR-F90/50DR

## Illuminance Distribution Chart (Ref. Value)

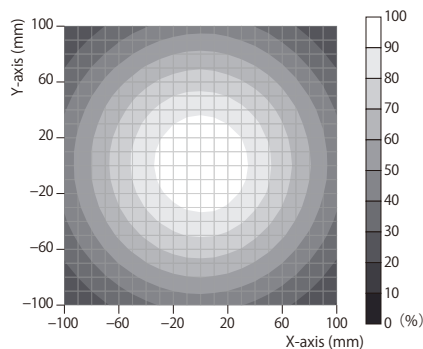

Excellent uniform illumination over a wide area is possible.  
Used Illumination: IDR-F110/60DW  
WD: 200mm

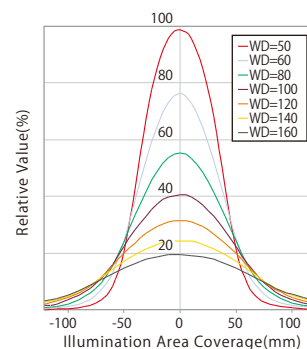

LEDs are implemented parallel to the work surface, making it possible to obtain a wide and uniform area.  
Used Illumination: IDR-F110/60DW

- IDBB-LSRF
- IDBC-LSR
- IDBB-LSRH
- IDBB-LSRA
- IDBB-LSRS
- IDBC-LSRC
- IDBB-LSRC
- IDBC-RE
- IDBB-RE
- IDBA-RK
- IQDH-RE
- IMAR-D\_8ch
- IDR-LA-8ch
- IDRA-T-8ch
- IMAR-D
- IMAR-CT D
- IHR-LE
- IHRB · IHRA
- IDR-F
- IDR-F33/16
- IDR
- IDR-LA
- IDRA-T
- IFR · IPR
- IDBA-HM
- IDBA-HMS
- IDBA-HMS-IR
- IDBA-FD
- IDBA-LEH2
- IDBA-LEH
- IDBA-LE
- IDBA-SE
- IDBA-SL
- IDBA
- IDBA-Q
- IFLA · IFLB
- IDHM
- IHMA
- IHMA-V
- IFPA
- IFD
- IFD-IR
- IHMA-40D
- IFPA-D
- IPOC
- IFHA
- IDDB-KH · IDDA-KH
- IDUB
- IDD
- IDD-CB
- IQD · IQDH
- IQDA-CB
- IFVA · IFVB
- IFVA-ST
- IFV
- IV-14 · IV-30
- IHV-20 · IHVE-21
- IHVA-SP · IHSL-SP
- IBF
- IHV-FX
- RBOX
- IDBB-CH
- IDHRA
- UV-CAN
- Infrared
- Infrared
- IMAR-RGB
- IDDA-KH-RGB
- RGB Full-color
- ISU
- ISS
- Introduction of Customization
- High-speed and high-resolution video products
- ISC-24
- Image capture evaluation kit products
- IDMU
- ILP
- ILC
- ILV
- ILS
- IPPA\_G · IRPA\_G
- IPSA · IPPA
- IDGC
- IDPA
- IDCA
- IMC
- IWDV-24
- IWDV(S)-48
- ISC
- IJS
- IJS-30M2-TP/SS
- ILS-40M2-PI/SS
- SAG
- SLLUB
- LLUB
- IFIC

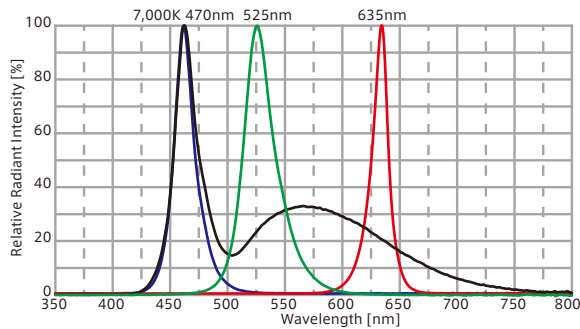

Model	Color	Power Consumption(W)	Input Voltage	SAG (※)	Applicable Controller	Drawing
IDR-F43/15□	DR	1.8	DC12V	C6	IDMU Series (P.193) ILP-30M2 (P.197) IDGC Series (P.209) Strobe/Overdrive Controllers, etc.	1
	DW B G	2.2		FF		
IDR-F50/15□	DR	3.1		DA		2
	DW B G	3.3		FF		
IDR-F60/32□	DR	3.6		C7		3
	DW B G	3.6		FF		
IDR-F70/37□	DR	4.9		D4		4
	DW B G	5.6		FF		
IDR-F90/50□	DR	7.3		F0		5
	DW B G	6.2		FF		
IDR-F100/50□	DR	8.5		FF		6
	DW B G	6.5		FF		
IDR-F110/60□	DR	12.1		E1		7
	DW B G	9.6		FF		

★The emission color (DW=White,DR=Red,B=Blue,G=Green) is indicated by □ in the model table.

★A diffuser plate and a polarizing plate can be attached.(Optional)

★DC24V products are also available. Please feel free to contact us for more information.

★Custom sizes are also available aside from the ones listed above.

※SAG: The maximum instantaneous upper limit output voltage setting value in the controller for the corresponding illumination when used in combination with the Overdrive controller.

### Singal Type Extension Cable For DC12V Illumination

#### I-CB-S Series

When used for moving parts such as robots, please use the I-CB-S\_R-C02 series, which manufactured with robust robot cable with high flexibility. For DC24V model, please use the I-CB-S\_R-24 series or I-CB-S\_R-24-C02 series.

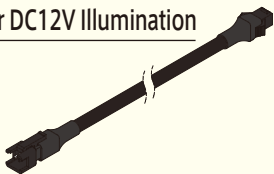

### Recommended Digital Controller(PWM Control)

#### IDMU Series

Output control: 1,000 Levels  
Compact PWM controller with DC24V input voltage, ideal for installation inside panels  
Expandable up to 40 channels by linking units  
Equipped with programming and camera trigger output functions, making it versatile.



### Diffuser Plate for IDR-F

#### IKR-F Series

This is a diffuser plate type for attaching to the front of IDR-F. By attaching it, light can be diffused and it is possible to reduce the reflection on the object. The standard transmittance is 80%, and there are also 90%, 60%, and 30% options available. For the red color (DR series), the standard transmittance is 60%. It can be easily attached and detached with screws.



Model	Applicable Illumination
IKR-F43/15-80	IDR-F43/15
IKR-F50/15-80	IDR-F50/15
IKR-F60/32-80	IDR-F60/32
IKR-F70/37-80	IDR-F70/37
IKR-F90/50-80	IDR-F90/50
IKR-F100/50-80	IDR-F100/50
IKR-F110/60-80	IDR-F110/60

### Polarizing Plate for IDR-F

#### IKR-F-PL Series

This is a polarizing plate that attaches to the front of IDR-F. By attaching a PL filter to the camera lens side as well, it is possible to cancel out object glare and surface reflections.

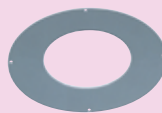

Model	Applicable Illumination
IKR-F43/15-PL	IDR-F43/15
IKR-F50/15-PL	IDR-F50/15
IKR-F60/32-PL	IDR-F60/32
IKR-F70/37-PL	IDR-F70/37
IKR-F90/50-PL	IDR-F90/50
IKR-F100/50-PL	IDR-F100/50
IKR-F110/60-PL	IDR-F110/60

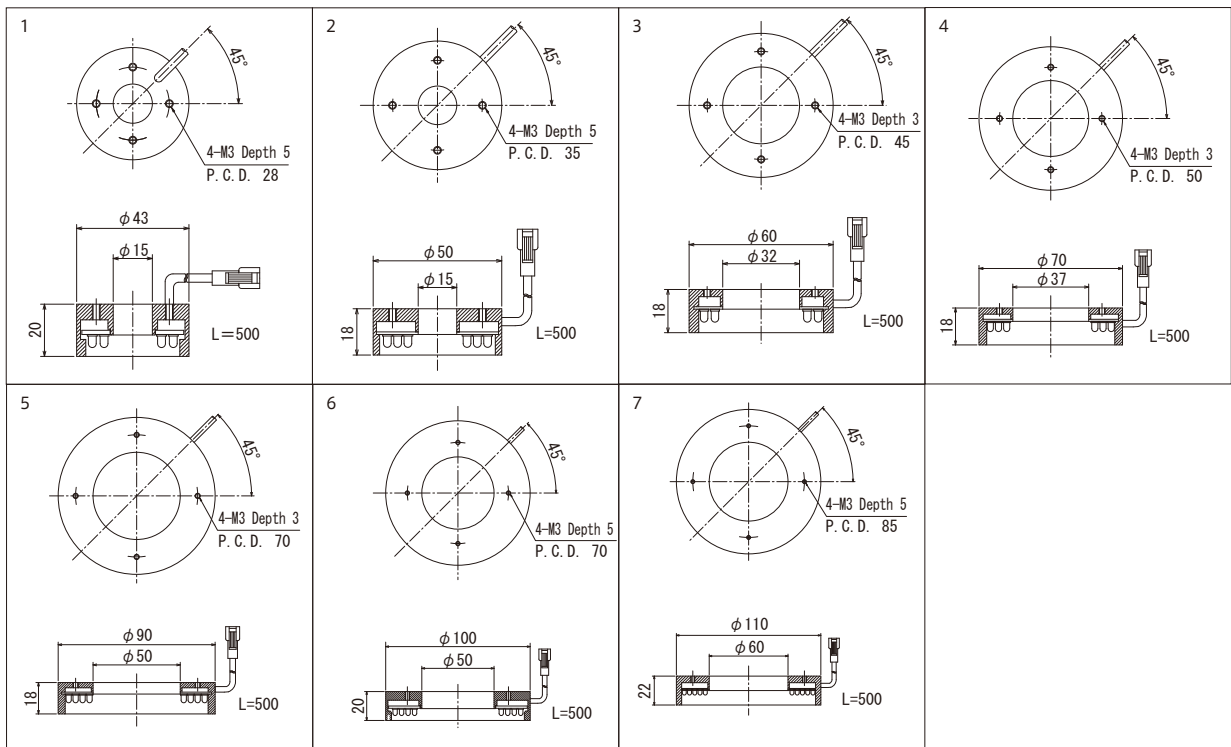

Line illumination products

Ring illumination products

Bar illumination products

Special illumination products

Special illumination products

Special illumination products

Special illumination products

Special illumination products

Special illumination products

- IDBB-LSRF
- IDBC-LSR
- IDBB-LSRH
- IDBB-LSRA
- IDBB-LSRS
- IDBC-LSRC
- IDBB-LSRC
- IDBB-RE
- IDBB-RE
- IDBA-RK
- IQDH-RE
- IMAR-D\_8ch
- IDR-LA-8ch
- IDRA-T-8ch
- IMAR-D
- IMAR-CT-D
- IHR-LE
- IHRB · IHRA
- IDR-F
- IDR-F33/16
- IDR
- IDR-LA
- IDRA-T
- IFR · IPR
- IDBA-HM
- IDBA-HMS
- IDBA-HMS-IR
- IDBA-FD
- IDBA-LEH2
- IDBA-LEH
- IDBA-LE
- IDBA-SE
- IDBA-SL
- IDBA
- IDBA-Q
- IFLA · IFLB
- IDHM
- IHMA
- IHMA-V
- IFPA
- IFD
- IFD-IR
- IHMA-40D
- IFPA-D
- IPQC
- IFHA
- IDDB-KH · IDDA-KH
- IDUB
- IDD
- IDD-CB
- IQD · IQDH
- IQDA-CB
- IFVA · IFVB
- IFVA-ST
- IFV
- IV-14 · IV-30
- IHV-20 · IHVE-21
- IHVA-SP · IHSL-SP
- IBF
- IHV-FX
- RBOX
- IDBB-CH
- IDHRA
- UV-CAN
- Infrared
- Infrared
- IMAR-RGB
- IDDA-KH-RGB
- RGB Full-color
- ISU
- ISS
- Introduction of Customization
- High speed synchronous imaging camera products
- ISC-24
- Image capture evaluation kit products
- IDMU
- ILP
- ILC
- ILV
- ILS
- IPPA\_G · IRPA\_G
- IPSA · IPPA
- IDGC
- IDPA
- IDCA
- IMC
- IWDV-24
- IWDV(S)-48
- ISC
- IJS
- IUS-30M2-TP/SS
- ILS-40M2-PI/SS
- SAG
- SLLUB
- LLUB
- IFIC