

High-Intensity Diffused Bar Illumination [IDBA-HM Series]

High-intensity diffused bar illumination with 40mm width
High-luminance and high-uniformity 2 types lined-up ,
which can be used for various appearance inspections

With an irradiation angle of 140 degrees and a luminous surface width of 40mm,
it is ideal for replacing fluorescent lamps.
Wide type with high uniformity of diffused light, minimizing brightness
unevenness at the front and back for large objects.

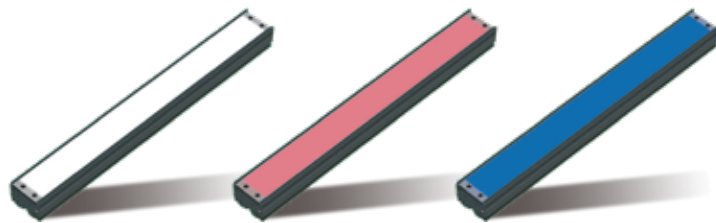
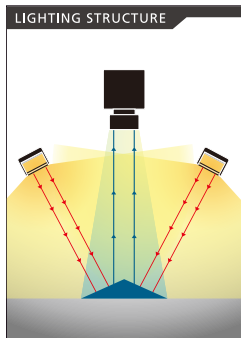

- Standard Size Lineup: 100 ~ 2,000mm (per. 100mm)
- Available with high-luminance specification that is suitable for direct illumination and high-uniformity specification that is for backlight use.

Wide-Angle Light Distribution...Allows for Illuminating A Wide Area.

It provides wide-angle illumination even compared to the IDBA-LE series,
making it ideal for replacing fluorescent lamps.



IDBA-HM400W
(High-Luminance Type)

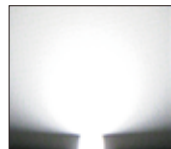

Enlarged image of emission surface



Reference: IDBA-LE3005-W
(Wide-angle light distribution type)

Luminance Comparison (Ref.Value)

The IDBA-HM series allows for illumination at nearly
the same level of luminance as the IDBA-LEH2 series
with a 60% diffuser plate and the IDBA-LE series with
a wide-angle light distribution specification (S type).

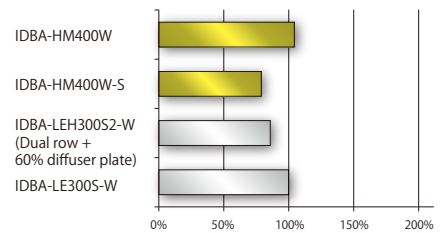

Illuminance Distribution Chart(Ref.Value)

Used Illumination: IDBA-HM400W

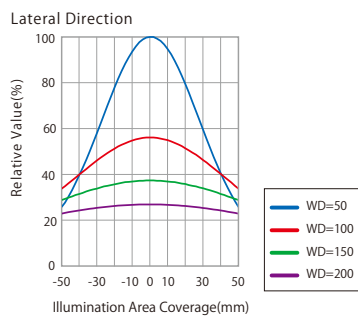
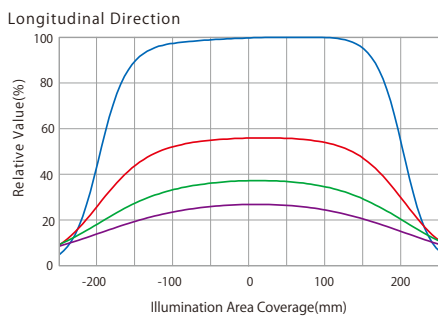

Luminance Distribution of the Emission Surface
(High-Luminance Type)

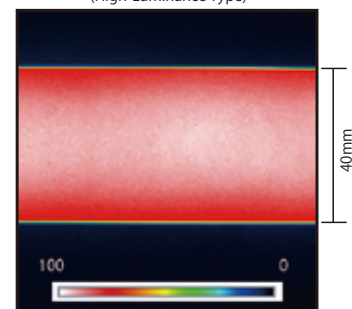

- IDBB-LSRF
- IDBC-LSR
- IDBB-LSRH
- IDBB-LSRA
- IDBB-LSRS
- IDBC-LSRC
- IDBB-LSRC
- IDBC-RE
- IDBB-RE
- IDBA-RK
- IQDH-RE
- IMAR-D_8ch
- IDR-LA-8ch
- IDRA-T-8ch
- IMAR-D
- IMAR-CT D
- IHR-LE
- IHRB · IHRA
- IDR-F
- IDR-F33/16
- IDR
- IDR-LA
- IDRA-T
- IFR · IPR
- IDBA-HM
- IDBA-HMS
- IDBA-HMS-IR
- IDBA-FD
- IDBA-LEH2
- IDBA-LEH
- IDBA-LE
- IDBA-SE
- IDBA-SL
- IDBA
- IDBA-Q
- IFLA · IFLB
- IDHM
- IHMA
- IHMA-V
- IFPA
- IFD-IR
- IHMA-40D
- IFPA-D
- IPOC
- IFHA
- IDDB-KH · IDDA-KH
- IDUB
- IDD
- IDD-CB
- IQD · IQDH
- IQDA-CB
- IFVA · IFVB
- IFVA-ST
- IFV
- IV-14 · IV-30
- IHV-20 · IHVE-21
- IHVA-SP · IHSL-SP
- IBF
- IHV-FX
- RBOX
- IDBB-CH
- IDHRA
- UV-CAN
- Infrared
- Infrared
- IMAR-RGB
- IDDA-KH-RGB
- RGB Full-color
- ISU
- ISS
- Introduction of Customization
- High speed and high magnification video IC products
- ISC-24
- Image capture evaluation kit products
- Kit products
- IDMU
- ILP
- ILC
- ILV
- ILS
- IPPA_G · IRPA_G
- IPSA · IPPA
- IDGC
- IDPA
- IDCA
- IMC
- IWDV-24
- IWDV(S)-48
- ISC
- IJS
- IJS-30M2-TP/SS
- ILS-40M2-PI/SS
- SAG
- SLLUB
- LLUB
- IFIC

Optical Spectrum (Ref.Value)

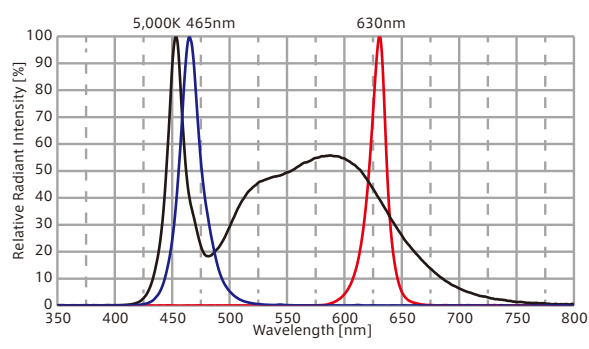

Model	Color	Power Consumption (W)	Input Voltage	Applicable Controllers	Drawing																
IDBA-HM100	R W B	10	DC24V	IDMU-24 Series(P.193) ILP-60M2-24(P.197) IDGC-24 Series(P.209) etc.	1																
IDBA-HM200	R W B	20				IWDV-100S-24 (P.217)	2														
IDBA-HM300	R W B	30						IWDV-300S-24 IWDV-600M2-24 (P.217)	2												
IDBA-HM400	R W B	40								IWDV-300S-24 IWDV-600M2-24 (P.217)	2										
IDBA-HM500	R W B	50										IWDV-300S-24 IWDV-600M2-24 (P.217)	2								
IDBA-HM600	R W B	60												IWDV-300S-24 IWDV-600M2-24 (P.217)	2						
IDBA-HM700	R W B	70														IWDV-300S-24 IWDV-600M2-24 (P.217)	2				
IDBA-HM800	R W B	80																IWDV-300S-24 IWDV-600M2-24 (P.217)	2		
IDBA-HM900	R W B	90																		IWDV-300S-24 IWDV-600M2-24 (P.217)	2
IDBA-HM1000	R W B	100																			
IDBA-HM1100	R W B	110		IWDV-300S-24 IWDV-600M2-24 (P.217)	2																
IDBA-HM1200	R W B	120				IWDV-300S-24 IWDV-600M2-24 (P.217)	2														
IDBA-HM1300	R W B	130						IWDV-300S-24 IWDV-600M2-24 (P.217)	2												
IDBA-HM1400	R W B	140								IWDV-300S-24 IWDV-600M2-24 (P.217)	2										
IDBA-HM1500	R W B	150										IWDV-300S-24 IWDV-600M2-24 (P.217)	2								
IDBA-HM1600	R W B	160												IWDV-300S-24 IWDV-600M2-24 (P.217)	2						
IDBA-HM1700	R W B	170														IWDV-300S-24 IWDV-600M2-24 (P.217)	2				
IDBA-HM1800	R W B	180																IWDV-300S-24 IWDV-600M2-24 (P.217)	2		
IDBA-HM1900	R W B	190																		IWDV-300S-24 IWDV-600M2-24 (P.217)	2
IDBA-HM2000	R W B	200																			

★ The emission color (W=White,R=Red,B=Blue) is indicated by □ in the model table. ★ For high-uniformity type, -S is indicated by ■ in the model table.
 ★ Custom sizes are also available aside from the ones listed above.
 ★ Please note that the illumination which length is over 700mm, cannot be directly connected to the controller, a connection cable of any length is necessary.
 ★ The I-CB-S-24 connection cable is intended for illuminations with a length of under 700mm. Please refer to P.248 for details. The I-CB-S-24-R-MCB connection cable is intended for illuminations with a length over 700mm. Please refer to P. 249 for details.
 The length of the cable (m) will be indicated in the ▼,▽ section.(▼=1,2,3,4,5,10)(▽=1, 2, 3, 5, 7, 10)

Connection Cable For DC24V Bar Illumination

I-CB-S_24 Series / I-CB-S_R-MCB Series

When used for moving parts such as robots, please use the I-CB-S_R-24-C02 series or I-CB-S_R-MCB series, which manufactured with robust robot cable with high flexibility.

Recommended Digital Controller(PWM Control)

IDMU-24 Series

Output control: 1,000 Levels
 Compact PWM controller with DC24V input voltage, ideal for installation inside panels
 Expandable up to 40 channels by linking units
 Equipped with programming and camera trigger output functions, making it versatile.

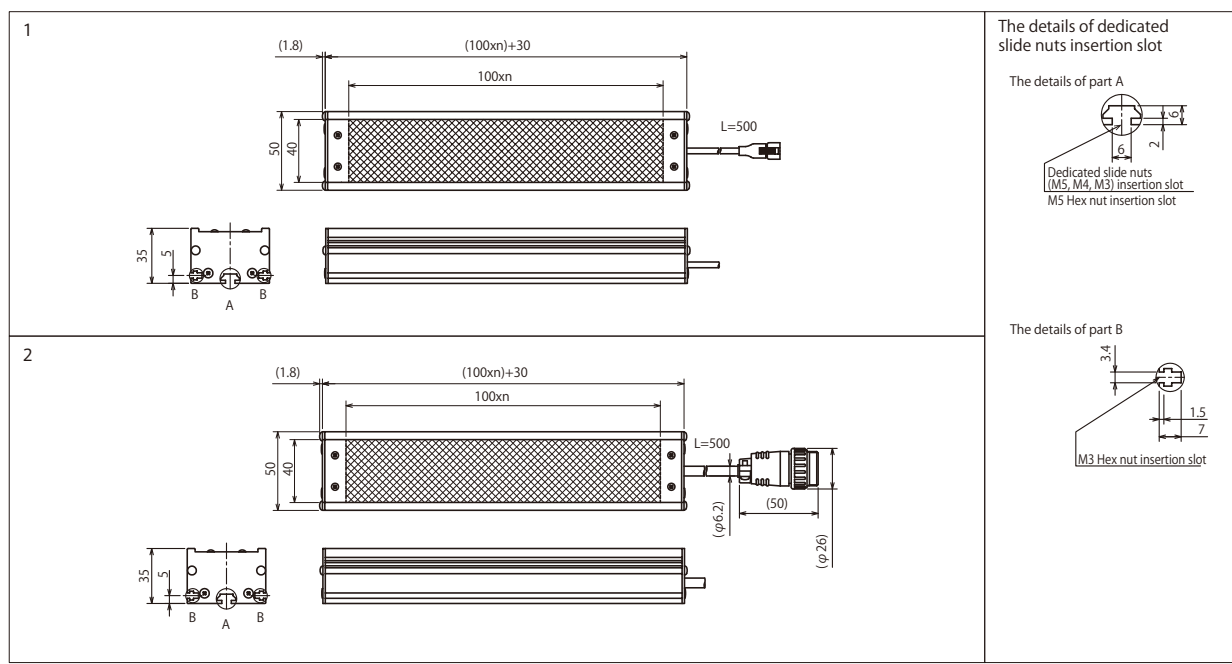

- Line illumination products
 - IDBB-LSRF
 - IDBB-LSR
 - IDBB-LSRH
 - IDBB-LSRA
 - IDBB-LSRS
 - IDBC-LSRC
 - IDBB-LSRC
 - IDBC-RE
 - IDBB-RE
 - IDBA-RK
 - IDH-RE
 - IMAR-D_8ch
 - IDR-LA-8ch
 - IDRA-T-8ch
 - IMAR-D
 - IMAR-CT D
 - IHR-LE
 - IHRB · IHRA
 - IDR-F
 - IDR-F33/16
 - IDR
 - IDR-LA
 - IDRA-T
 - IFR · IPR
- Ring illumination products
 - IDBA-HM
 - IDBA-HMS
 - IDBA-HMS-IR
 - IDBA-FD
 - IDBA-LEH2
 - IDBA-LEH
 - IDBA-LE
 - IDBA-SE
 - IDBA-SL
 - IDBA
 - IDBA-Q
 - IFLA · IFLB
 - IDHM
 - IHMA
 - IHMA-V
 - IFPA
 - IFD
 - IFD-IR
 - IHMA-40D
 - IFPA-D
 - IPQC
 - IFHA
 - IDDB-KH · IDDA-KH
 - IDUB
 - IDD
 - IDD-CB
 - IQD · IQDH
 - IQDA-CB
 - IFVA · IFVB
 - IFVA-ST
 - IFV
 - IV-14 · IV-30
 - IHV-20 · IHVE-21
 - IHVA-SP · IHSL-SP
- Bar illumination products
 - IBF
 - IHV-FX
 - RBOX
 - IDBB-CH
 - IDHRA
 - UV-CAN
 - Infrared
 - Infrared
 - IMAR-RGB
 - IDDA-KH-RGB
 - RGB Full-color
 - ISU
 - ISS
- Special illumination products
 - Introduction of Customization
 - High-speed synchronous imaging camera products
 - ISC-24
 - Image capture evaluation kit products
- Other products
 - IDMU
 - ILP
 - ILC
 - ILV
 - ILS
- Controller products
 - IPPA_G · IRPA_G
 - IPSA · IPPA
 - IDGC
 - IDPA
 - IDCA
 - IMC
 - IWDV-24
 - IWDV(S)-48
 - ISC
 - IJS
 - IJS-30M2-TP/SS
 - ILS-40M2-PI/SS
 - SAG
 - SLLUB
 - LLUB
 - IFIC